



Whale Animal Cracker



Have a whale of a time on a playground that features a Whale Animal Cracker from The 4 Kids! We offer this unique play component for use in any number of settings, including daycare play yards, public parks, splash pads and nautical themed commercial venues. Choose any color you'd like and we'll create a custom Whale Animal Cracker that's perfect for your project. Plus, our Animal Crackers are made from durable, reliable materials that stand up to all kinds of weather conditions and offer years of active play. This little Whale would make for a great water feature at splash parks.

The 4 Kids was born out of a desire to create high quality, one-of-a-kind park shelters and play environments that effectively appeal to children's natural curiosity and imagination.

All of our products are custom designed to work perfectly with your unique playground. Let us know how we can meet your specific needs by contacting our knowledgeable design specialists, today.

Contact Us

Ordering from The 4 Kids is easy, initial consultation & quote is free.
We can also provide you with design ideas and conceptual drawings.
We want your whole experience with The 4 Kids to be smooth & rewarding.

4400 Oneal St. Greenville, TX 75401

903.454.9237

info@the4kids.com

www.the4kids.com

Let our team of experienced engineers and artists make your playground the destination for fun! We can create an exciting space where children's imaginations can run wild. A playscape where parents can feel secure and create lasting memories with their whole family.

Key Features

- Exceptional customer service
- Created for toddlers and elementary school aged children
- Crafted to specific safety standards
- Super low maintenance
- No cost initial consultation

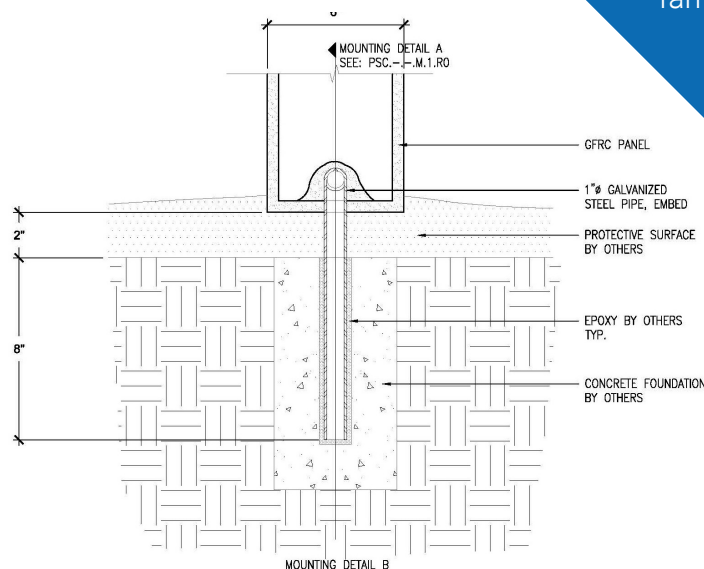
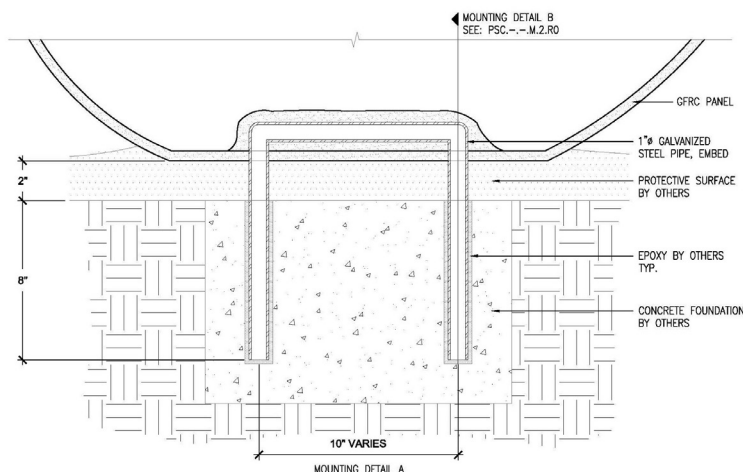

Specifications

Use Zone:
22'7\"/>

Mounting Options:
See Typical
Installation Details

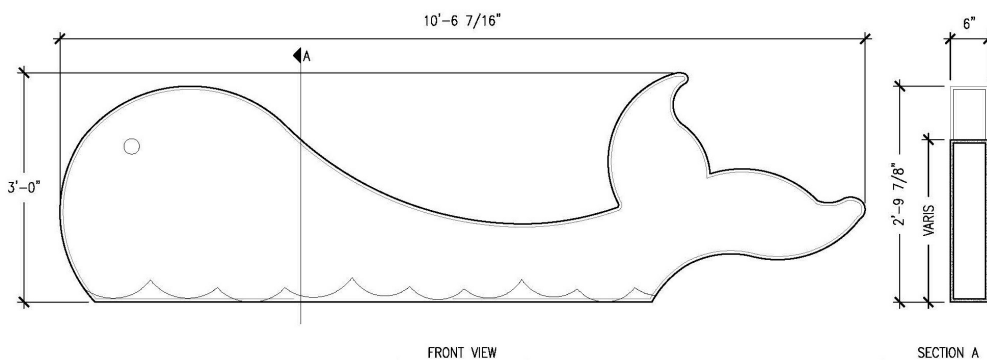
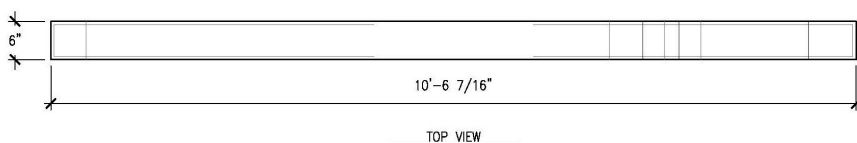

Contact Us

Ordering from The 4 Kids is easy, initial consultation & quote is free. We can also provide you with design ideas and conceptual drawings. We want your whole experience with The 4 Kids to be smooth & rewarding.

4400 Oneal St. Greenville, TX 75401

903.454.9237

info@the4kids.com

www.the4kids.com

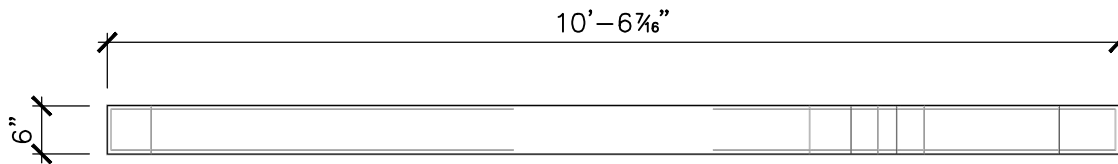

TOP VIEW

SCALE: 1/2" = 1'

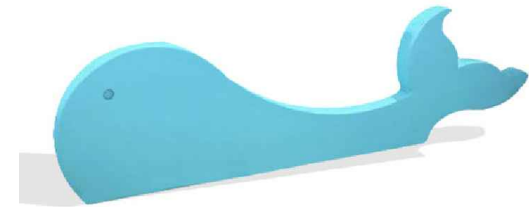

PRODUCT VIEW

SCALE: 1/2" = 1'

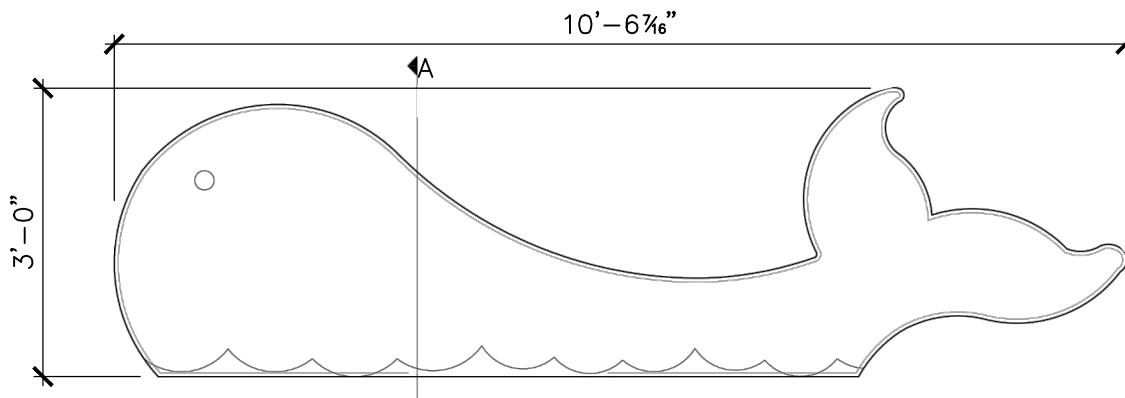

FRONT VIEW

SCALE: 1/2" = 1'

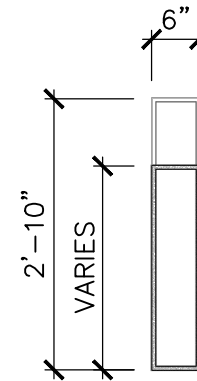

SECTION A

SCALE: 1/2" = 1'

ALL RIGHTS RESERVED. THIS DRAWING IS PROPERTY OF THE 4 KIDS INC. AND MAY BE USED ONLY WHEN UTILIZING THE 4 KIDS INC. GENERAL TERMS AND CONDITIONS APPLY AND ARE INCORPORATED HERE IN BY REFERENCE. THIS DETAIL MAY NOT APPLY TO ALL CONDITIONS AND CONSTRUCTION SITUATIONS.

ITEM ID: ANI103

MATERIAL:

MOLD

APX. TTL. WEIGHT

TOTAL # OF ITEM:

- LBS. [- KG]

TOTAL SQ. FEET: - [- sqm.]

PROJECT:

TITLE: WHALE ANIMAL CRACKER

REFERENCES:

COLOR & PER APPROVED SAMPLE
TEXTURE: PER APPROVED SAMPLE



CUSTOM THEMED PLAYGROUNDS

4400 ONEAL STREET, GREENVILLE, TX 75401 PHONE 903.454.9237 FAX 903.454.3642

TYPE DWG: FABRICATION

DRAWN BY:

DATE:

SCALE: AS NOTED

SHEET:

DWG. SHEET:



WHALE ANIMAL CRACKER
127" X 6" X 36"

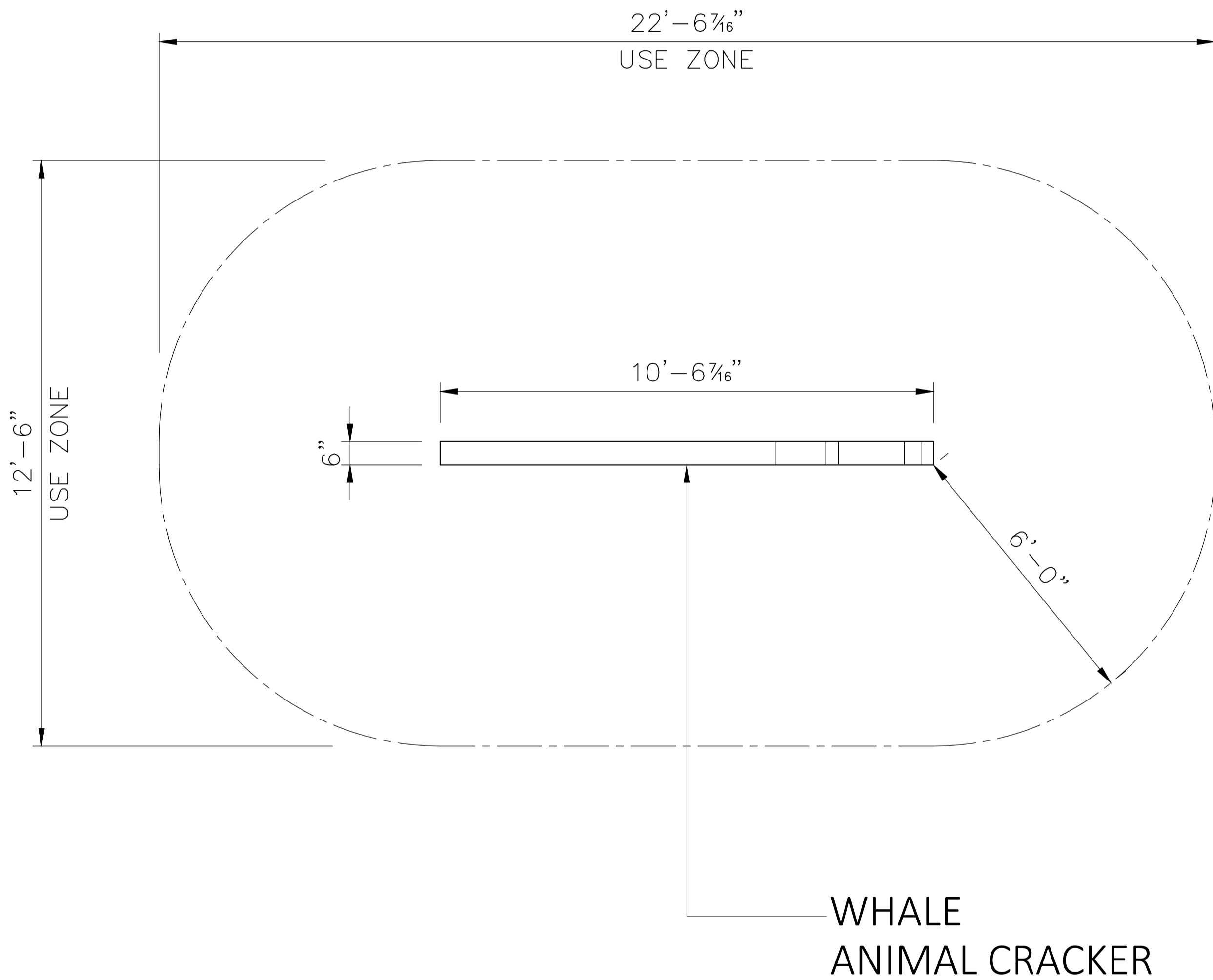

TOP VIEW

SCALE: 1/2" = 1'-0"