



## Sign 6



Clean lines and varied shapes create an attractive design for supporting important signage for every location as part of this amazing The 4 Kids sign structure from the experts in their Greenville, Texas studios. Making sure that customers at the mall, patients at the physician's clinic, children at the zoo, the ball park, or school, or even members of the public at government buildings are properly welcomed and clearly informed, this superior sign design is not only functional, but high quality. Made to withstand everything the weather can throw at it, this superior sign structure is virtually indestructible with very little maintenance for years of service in rain, snow, ice, intense heat and even the salt spray from the sea. Constructed with the "smart" concrete, glass fiber reinforced concrete, this customized sign structure design comes in heights of 3, 4, 5 or 6 feet with another one foot and three inches for sign supports that are mounted on an attractive brick base. From hospitals to hotels, shopping centers to day care centers, courthouses to colleges and everything in between, The 4 Kids sign structures are far superior to others.

The 4 Kids was born out of a desire to create high quality, one-of-a-kind park shelters and play environments that effectively appeal to children's natural curiosity and imagination.

All of our products are custom designed to work perfectly with your unique playground. Let us know how we can meet your specific needs by contacting our knowledgeable design specialists, today.

### Contact Us

Ordering from The 4 Kids is easy, initial consultation & quote is free.  
We can also provide you with design ideas and conceptual drawings.  
We want your whole experience with The 4 Kids to be smooth & rewarding.

4400 Oneal St. Greenville, TX 75401

903.454.9237

info@the4kids.com

www.the4kids.com

## Why Use Us?

Let our team of experienced engineers and artists make your playground the destination for fun! We can create an exciting space where children's imaginations can run wild. A playscape where parents can feel secure and create lasting memories with their whole family.

## Key Features

- Customized designs
- American made in Texas
- Impressive creation that attracts the eye
- Virtually no maintenance required
- GFRC construction

## Specifications

### Dimensions:

3', 4', 5', 6'

### Mounting Options:

See Typical  
Installation Details



## Contact Us

Ordering from The 4 Kids is easy, initial consultation & quote is free. We can also provide you with design ideas and conceptual drawings. We want your whole experience with The 4 Kids to be smooth & rewarding.

4400 Oneal St. Greenville, TX 75401

903.454.9237

info@the4kids.com

www.the4kids.com

© 2014 The 4 Kids Inc. All rights reserved.

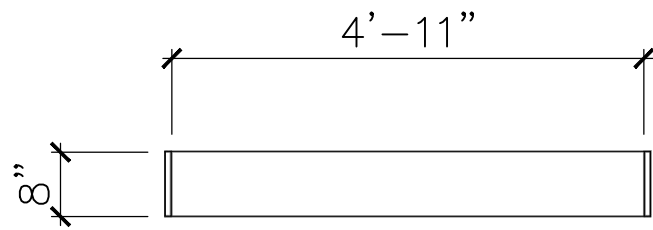

### TOP VIEW

SCALE: 1/2" = 1'

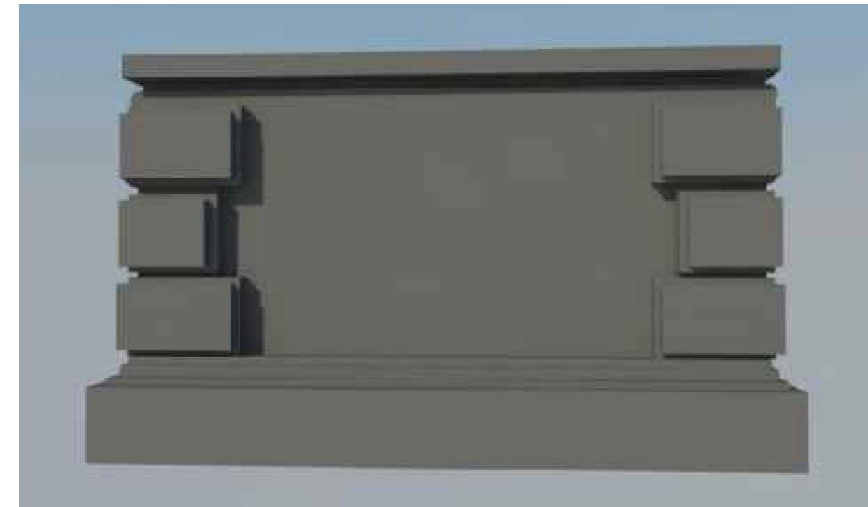

### PRODUCT VIEW

SCALE: 1/2" = 1'

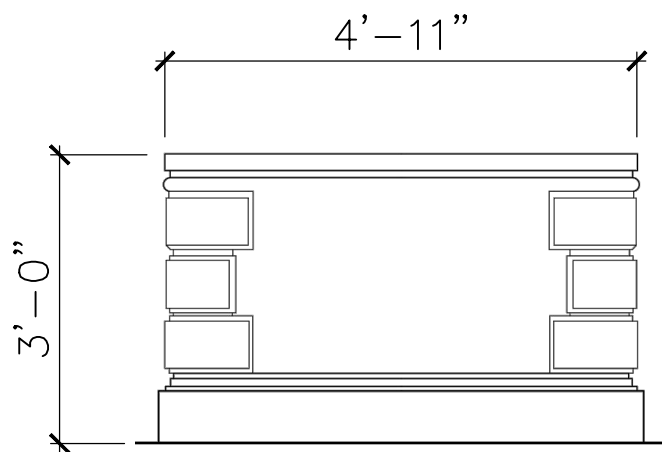

### FRONT VIEW

SCALE: 1/2" = 1'

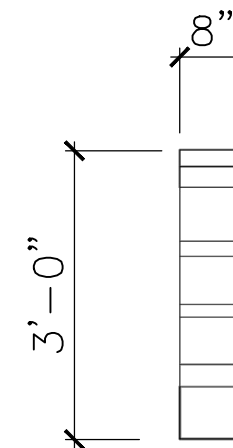

### RIGHT-SIDE VIEW

SCALE: 1/2" = 1'

ALL RIGHTS RESERVED. THIS DRAWING IS PROPERTY OF THE 4 KIDS INC. AND MAY BE USED ONLY WHEN UTILIZING THE 4 KIDS INC. GENERAL TERMS AND CONDITIONS APPLY AND ARE INCORPORATED HERE IN BY REFERENCE. THIS DETAIL MAY NOT APPLY TO ALL CONDITIONS AND CONSTRUCTION SITUATIONS.

ITEM ID: SIG121

MATERIAL: GFRC

MOLD

APX. TTL. WEIGHT

TOTAL # OF ITEM:

- LBS. [ - KG]

TOTAL SQ. FEET: - [- sqm.]

PROJECT:

TITLE: SIGN 6-3'H

REFERENCES:

COLOR & PER APPROVED SAMPLE  
TEXTURE: PER APPROVED SAMPLE



**CUSTOM THEMED PLAYGROUNDS**

4400 ONEAL STREET, GREENVILLE, TX 75401 PHONE 903.454.9237 FAX 903.454.3642

TYPE DWG: FABRICATION

DRAWN BY:

DATE:

SCALE: AS NOTED

SHEET:

DWG. SHEET:

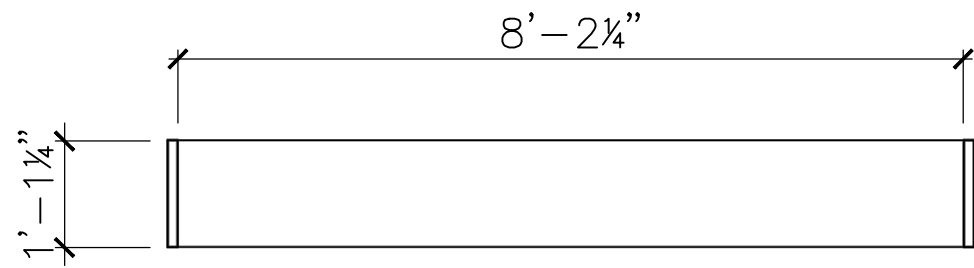

**TOP VIEW**

SCALE: 1/2" = 1'



**PRODUCT VIEW**

SCALE: 1/2" = 1'

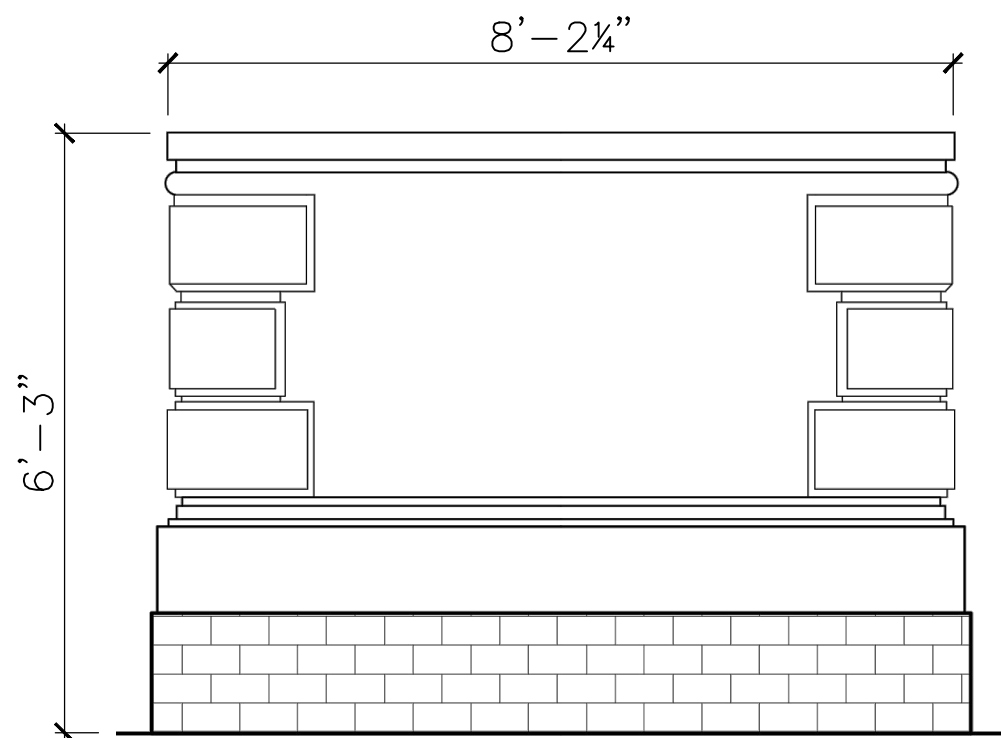

**FRONT VIEW**

SCALE: 1/2" = 1'

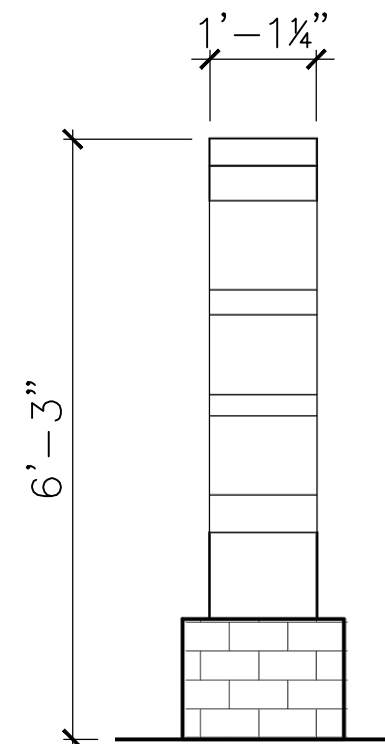

**RIGHT-SIDE VIEW**

SCALE: 1/2" = 1'

ALL RIGHTS RESERVED. THIS DRAWING IS PROPERTY OF THE 4 KIDS INC. AND MAY BE USED ONLY WHEN UTILIZING THE 4 KIDS INC. GENERAL TERMS AND CONDITIONS APPLY AND ARE INCORPORATED HERE IN BY REFERENCE. THIS DETAIL MAY NOT APPLY TO ALL CONDITIONS AND CONSTRUCTION SITUATIONS.

**ITEM ID: SIG121**

**MATERIAL: GFRC**

MOLD

APX. TTL. WEIGHT

TOTAL # OF ITEM:

- LBS. [ - KG]

TOTAL SQ. FEET: - [- sqm.]

PROJECT:

TITLE: SIGN 6B

REFERENCES:

COLOR & PER APPROVED SAMPLE  
TEXTURE: PER APPROVED SAMPLE



**CUSTOM THEMED PLAYGROUNDS**

4400 ONEAL STREET, GREENVILLE, TX 75401 PHONE 903.454.9237 FAX 903.454.3642

TYPE DWG: FABRICATION

DRAWN BY:

DATE:

SCALE: AS NOTED

SHEET:

DWG. SHEET: